

# LEAST MATERIAL CONDITION

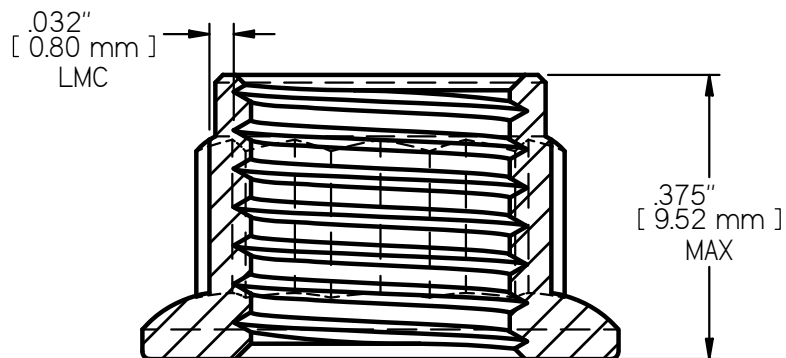
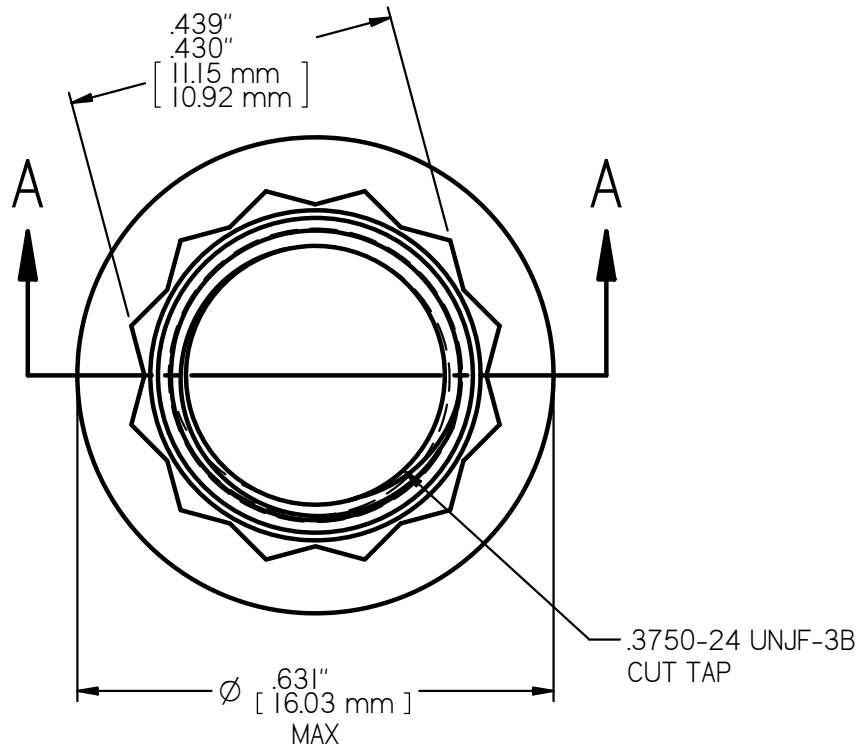

SECTION A-A  
4X SCALE

**NAS1804-6 LOCK NUT**  
**AXIAL STRENGTH: 17,100 LBS. [76,065 N.] MIN**