

# LEAST MATERIAL CONDITION

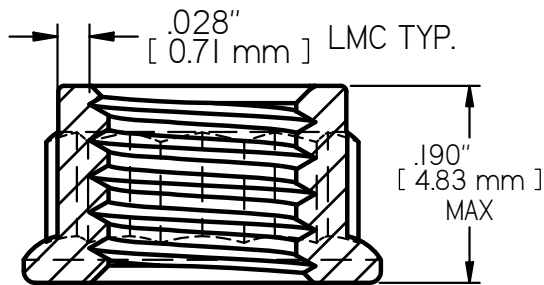
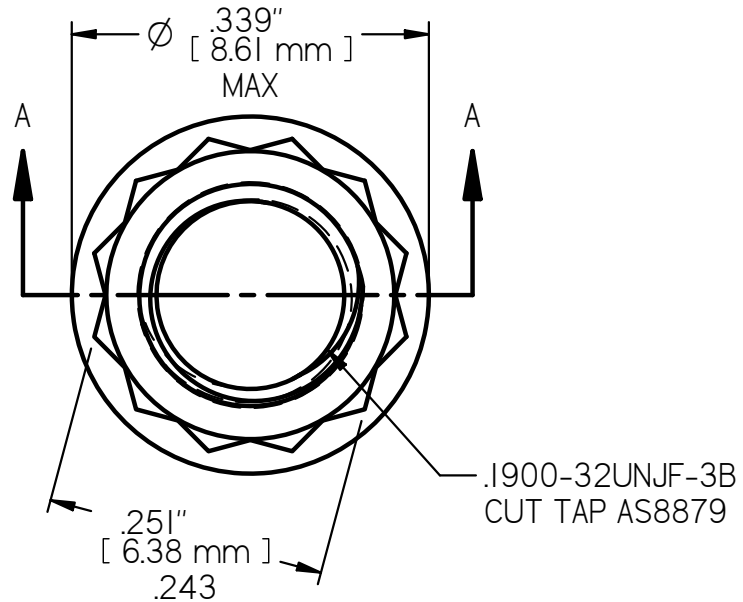

SECTION A-A  
6X SCALE

**NAS1804-3 LOCK NUT**  
**AXIAL STRENGTH: 4,070 LBS. [18,105 N.] MIN**