

LEAST MATERIAL CONDITION

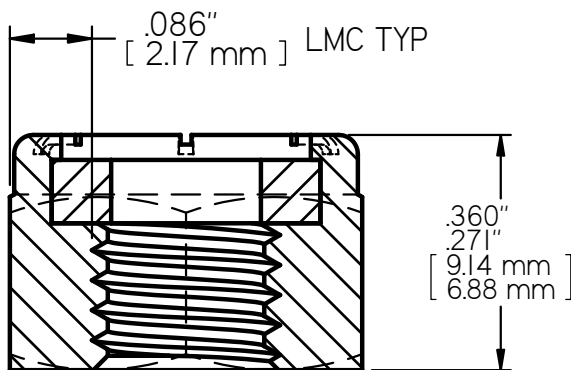
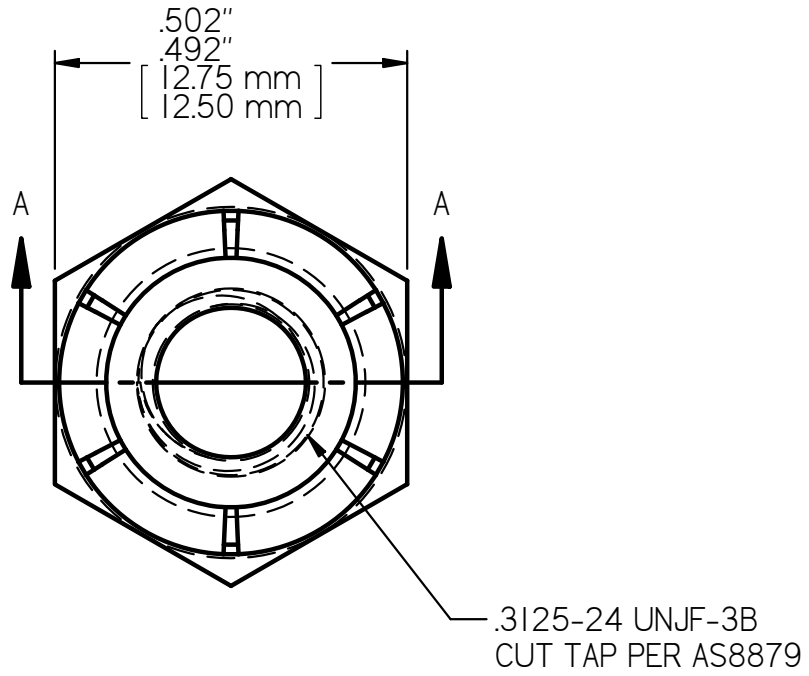

SECTION A-A
4X SCALE

MS21044N5 LOCK NUT
AXIAL STRENGTH: 7,390 LBS. [32,872 N.] MIN