

LEAST MATERIAL CONDITION

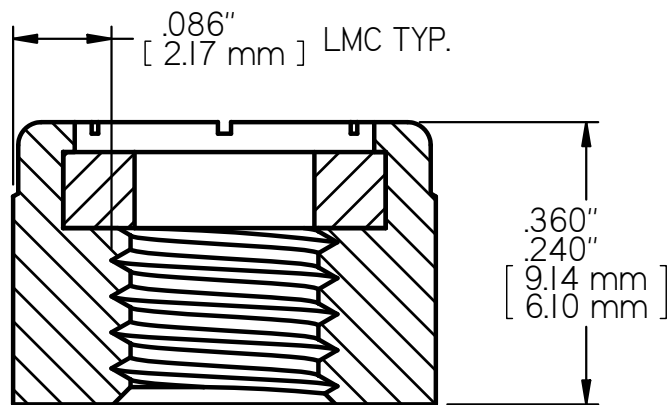
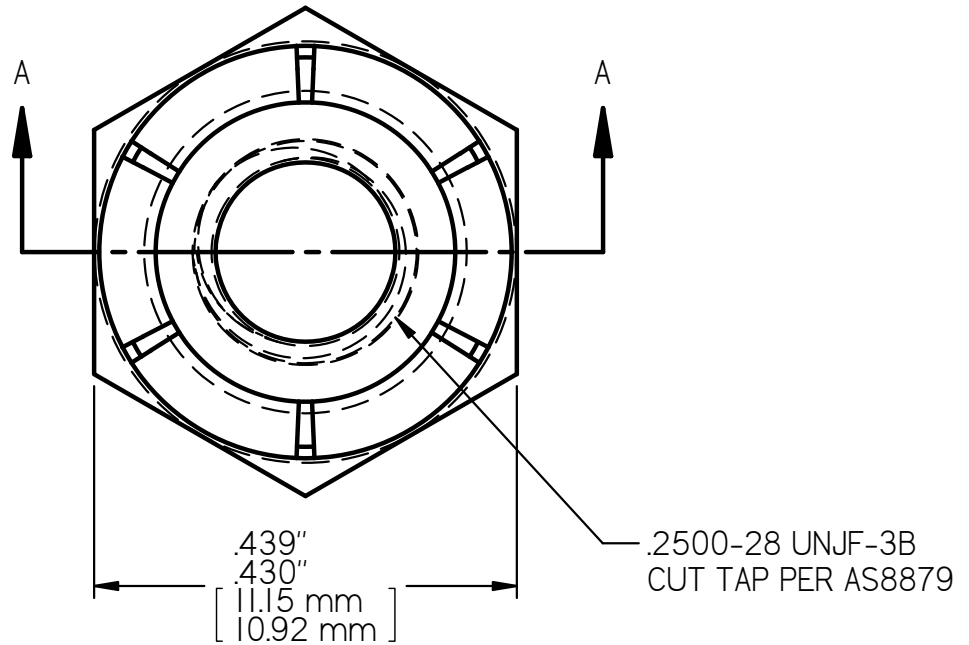

SECTION A-A
5X SCALE

MS21044N4 LOCK NUT
AXIAL STRENGTH: 4,580 LBS. [20,373 N.] MIN