

LEAST MATERIAL CONDITION

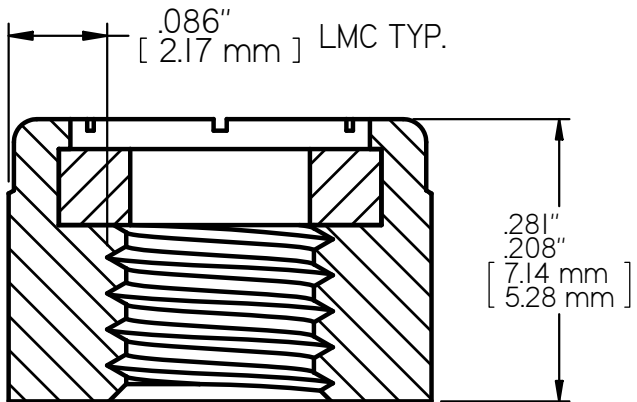
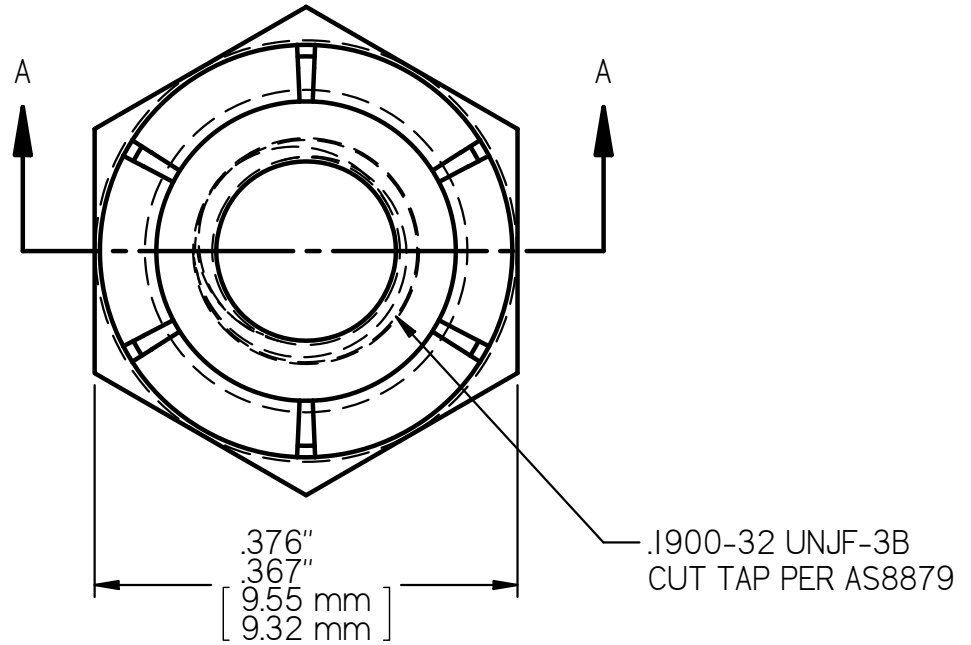

MS21044N3 LOCK NUT
AXIAL STRENGTH: 2,460 LBS. [10,943 N.] MIN