

LEAST MATERIAL CONDITION

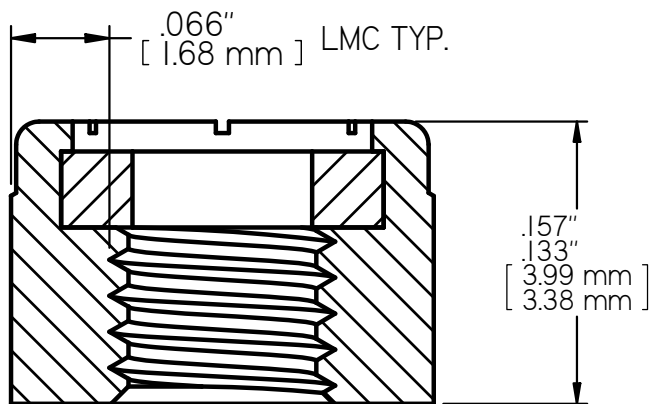
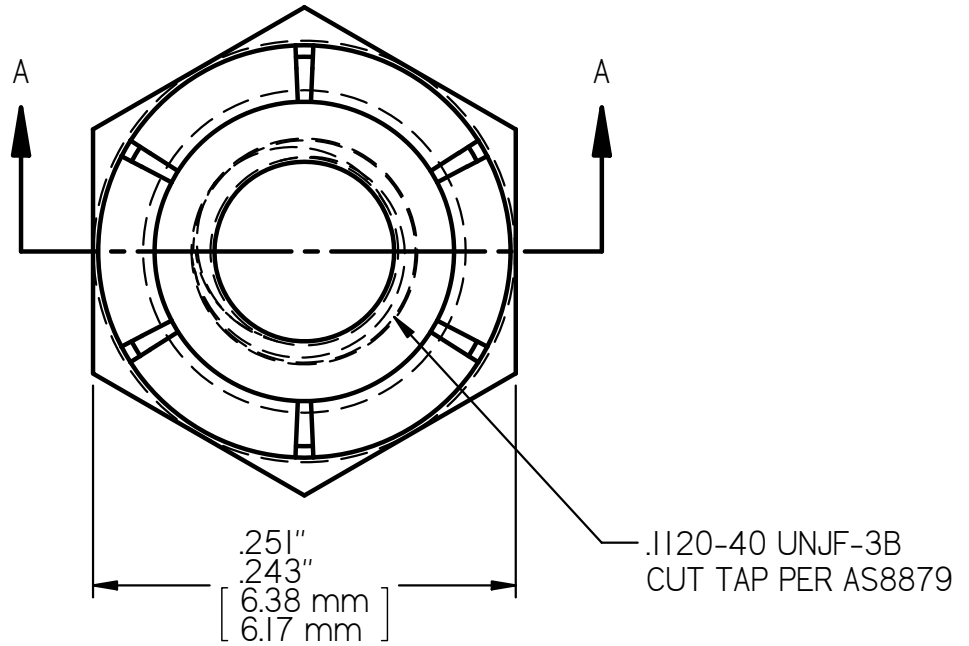

SECTION A-A
8X SCALE

MS21044N04 LOCK NUT
AXIAL STRENGTH: 750 LBS. [3,336 N.] MIN