

LEAST MATERIAL CONDITION

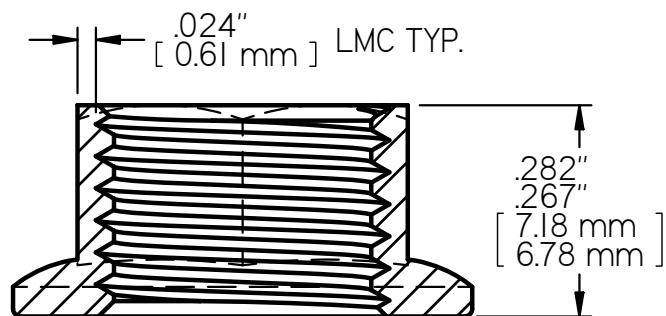
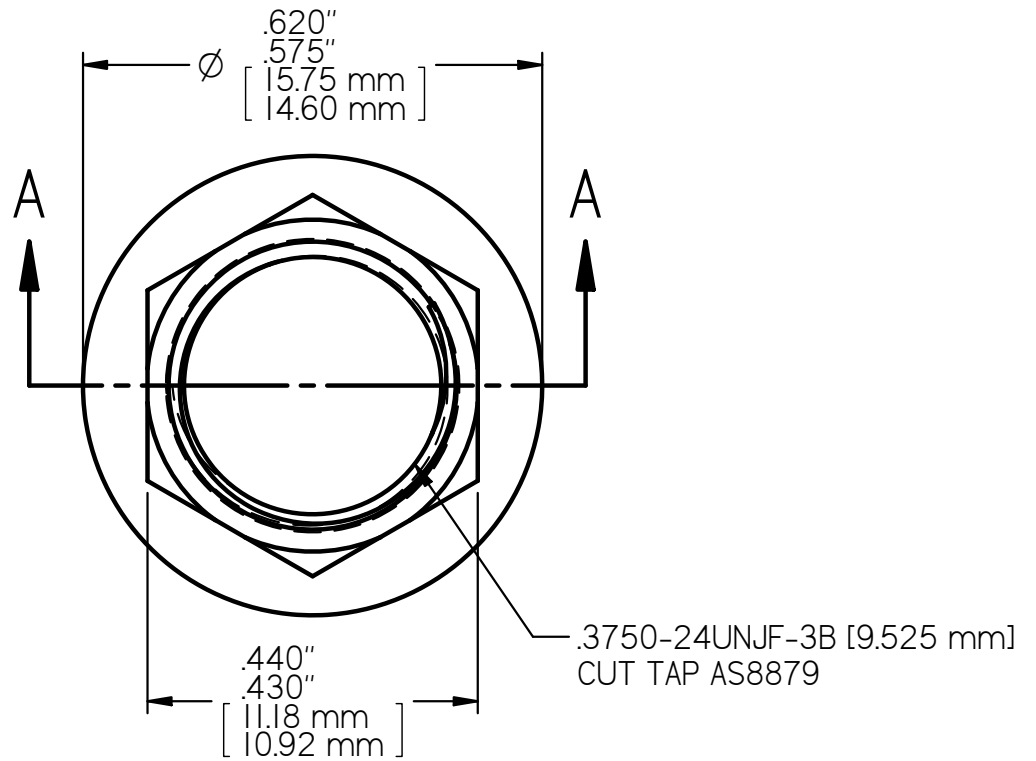

SECTION A-A
4X SCALE

MS21043-6 LOCK NUT
AXIAL STRENGTH: 11,450 LBS. [50,932 N.] MIN