

# LEAST MATERIAL CONDITION

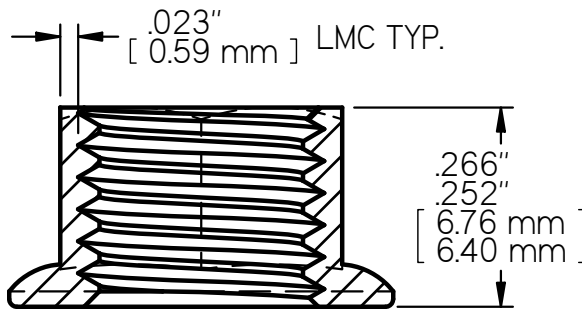
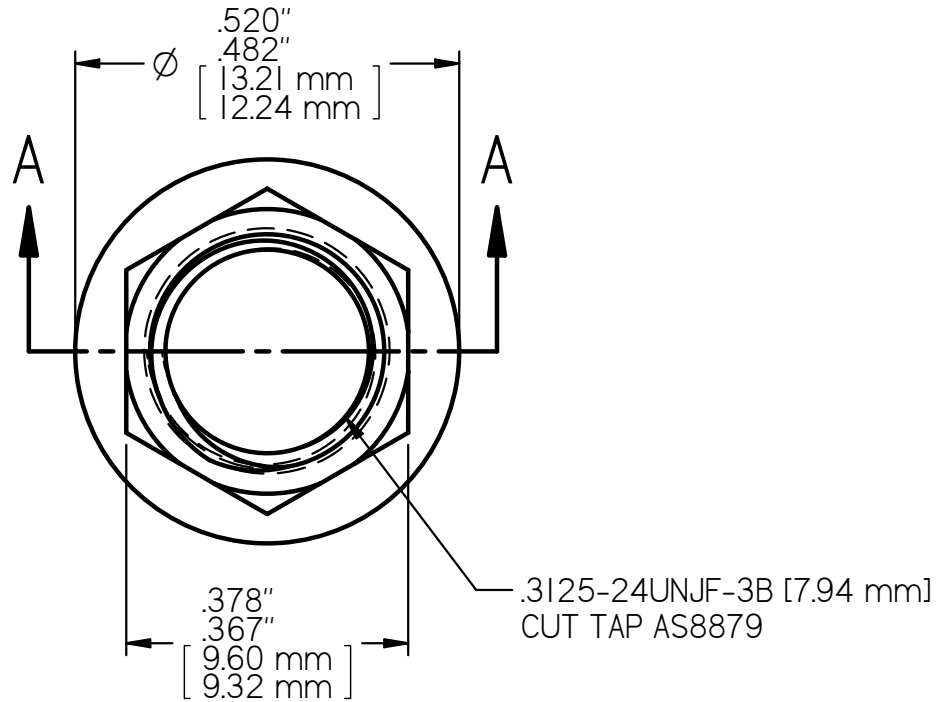

SECTION A-A  
4X SCALE

**MS21043-5 LOCK NUT**  
**AXIAL STRENGTH: 7,390 LBS. [32,872 N.] MIN**