

# LEAST MATERIAL CONDITION

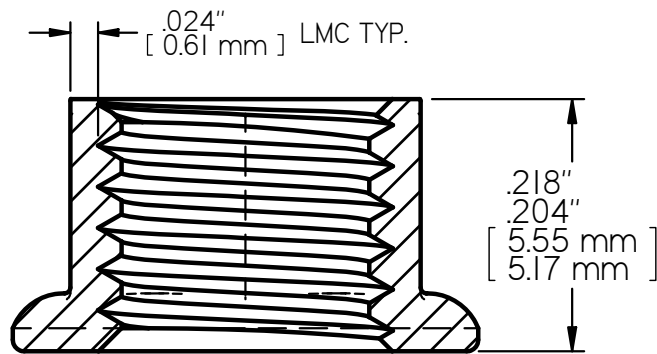
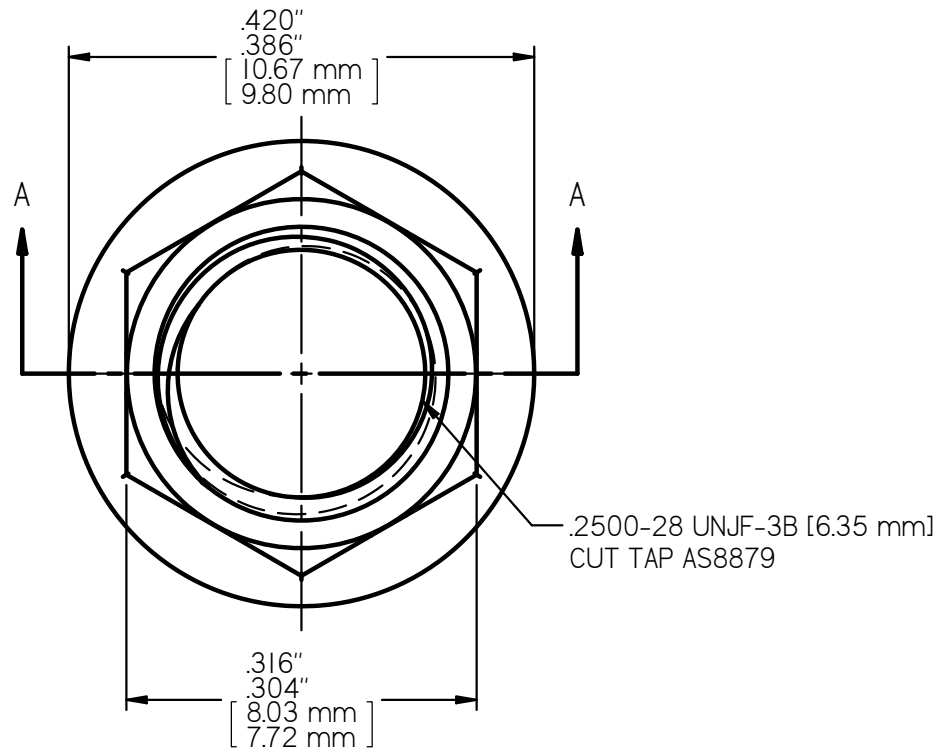

SECTION A-A  
6X SCALE

**MS21043-4 LOCK NUT**  
**AXIAL STRENGTH: 4,580 LBS. [20,373 N.] MIN**