

LEAST MATERIAL CONDITION

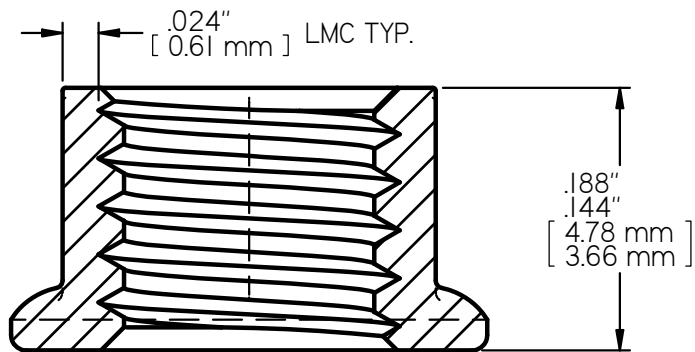
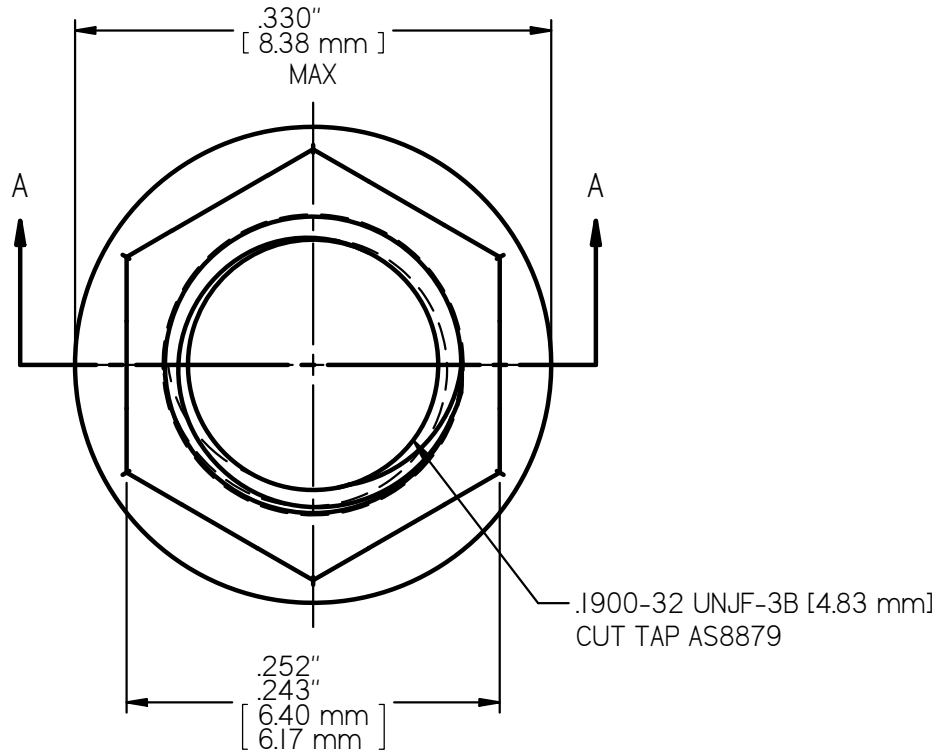

SECTION A-A
8X SCALE

MS21043-3 LOCK NUT
AXIAL STRENGTH: 2,460 LBS. [10,943 N.] MIN