

# LEAST MATERIAL CONDITION

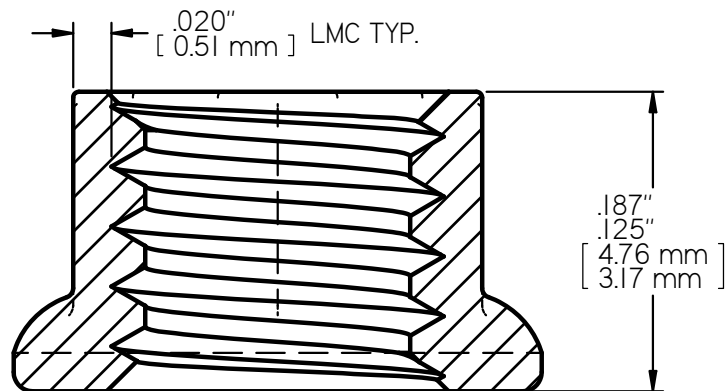
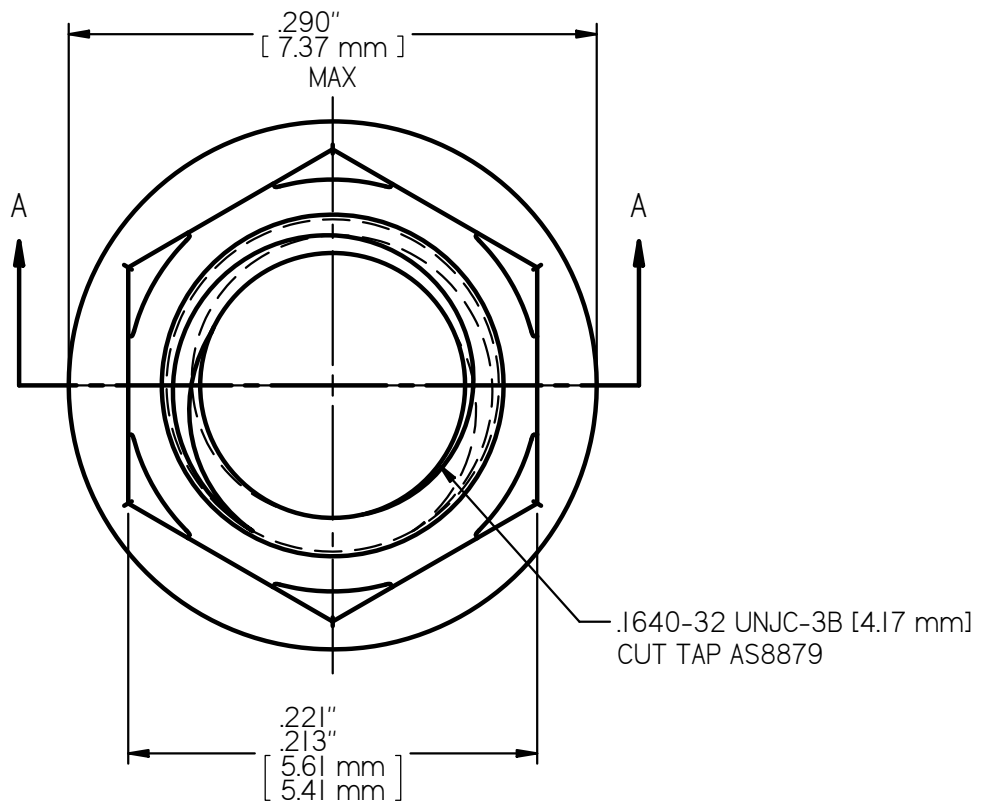

SECTION A-A  
10X SCALE

**MS21043-08 LOCK NUT**  
**AXIAL STRENGTH: 1,720 LBS. [7,651 N.] MIN**