

LEAST MATERIAL CONDITION

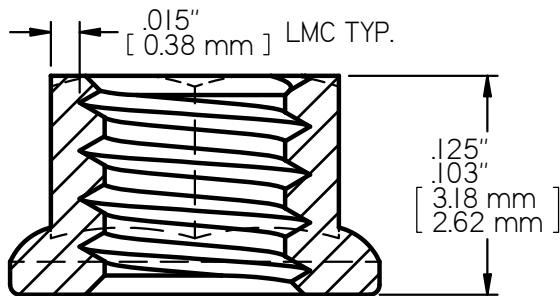
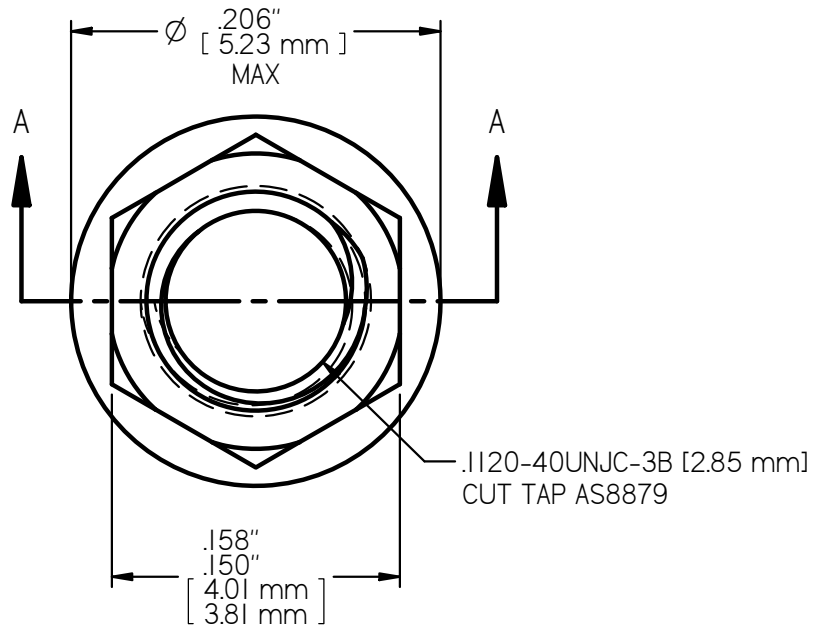

SECTION A-A
10X SCALE

MS21043-04 LOCK NUT
AXIAL STRENGTH: 760 LBS. [3,381 N.] MIN