

LEAST MATERIAL CONDITION

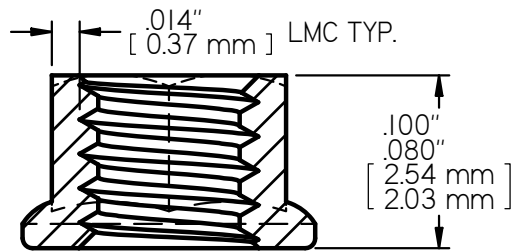
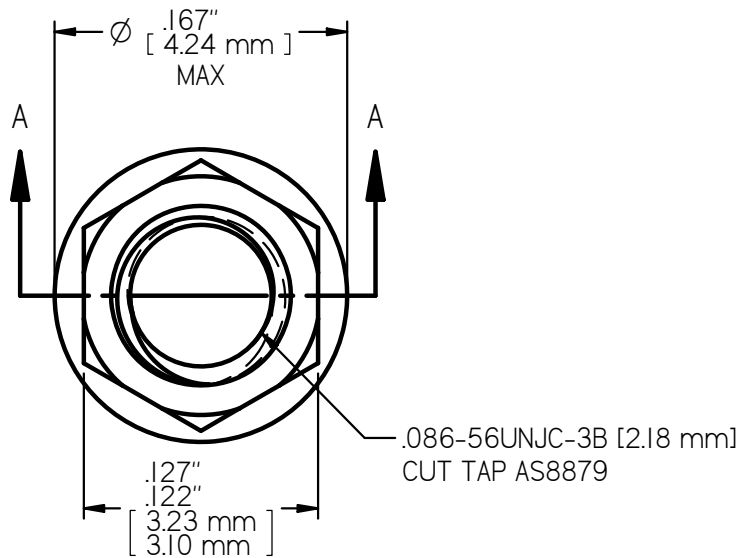

SECTION A-A

10X SCALE

MS21043-02 LOCK NUT
AXIAL STRENGTH: 465 LBS. [2,068 N.] MIN