

LEAST MATERIAL CONDITION

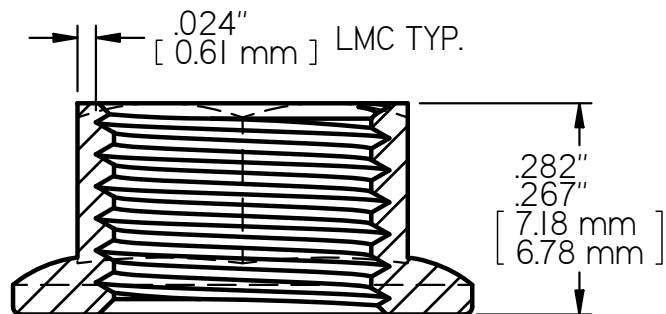
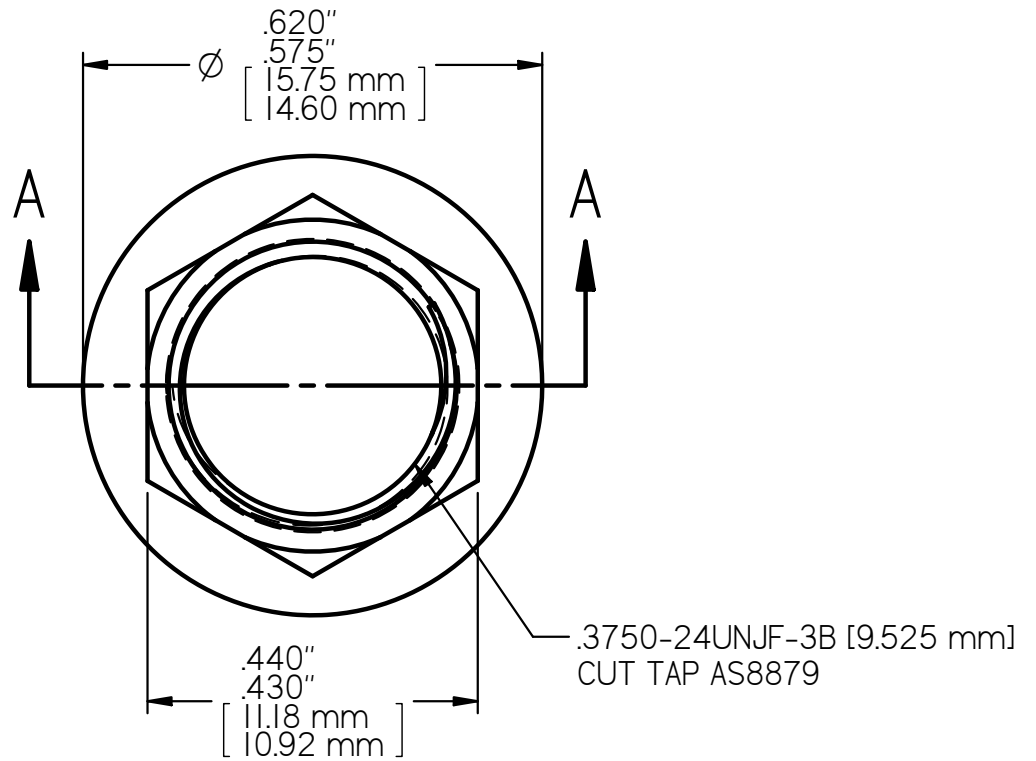

SECTION A-A
4X SCALE

MS21042-6 LOCK NUT
AXIAL STRENGTH: 15,200 LBS. [67,613 N.] MIN