

LEAST MATERIAL CONDITION

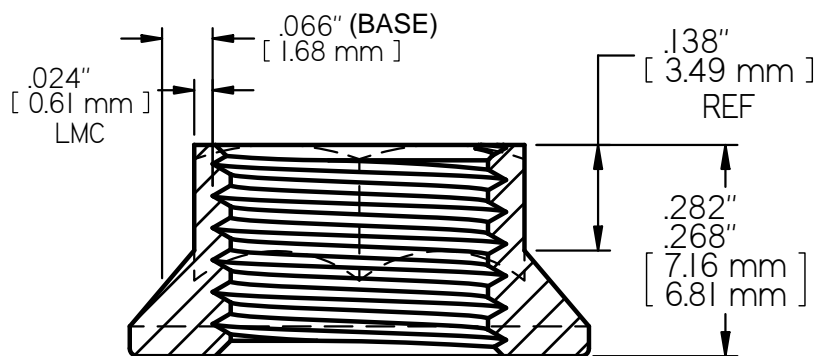
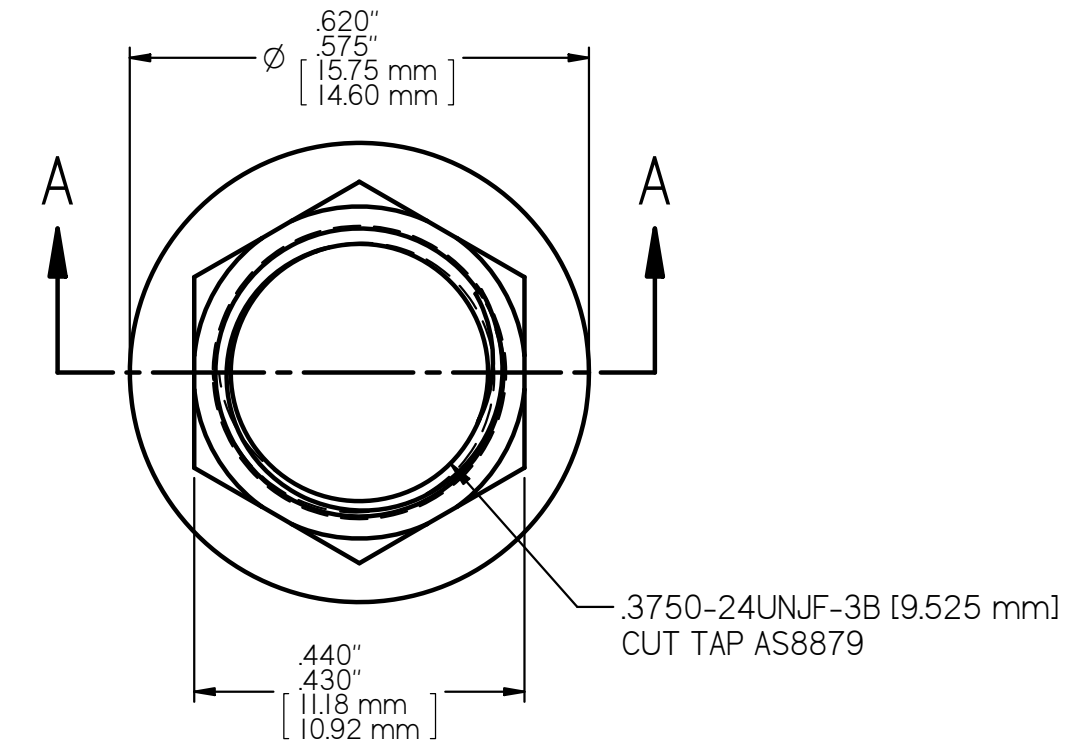

SECTION A-A
4X SCALE

**MS21042-6 LOCK NUT
STYLE "B" BELL FLANGE
AXIAL STRENGTH: 15,200 LBS. [67,613 N.] MIN**