

# LEAST MATERIAL CONDITION

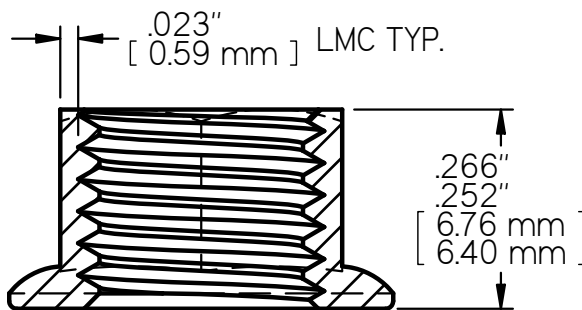
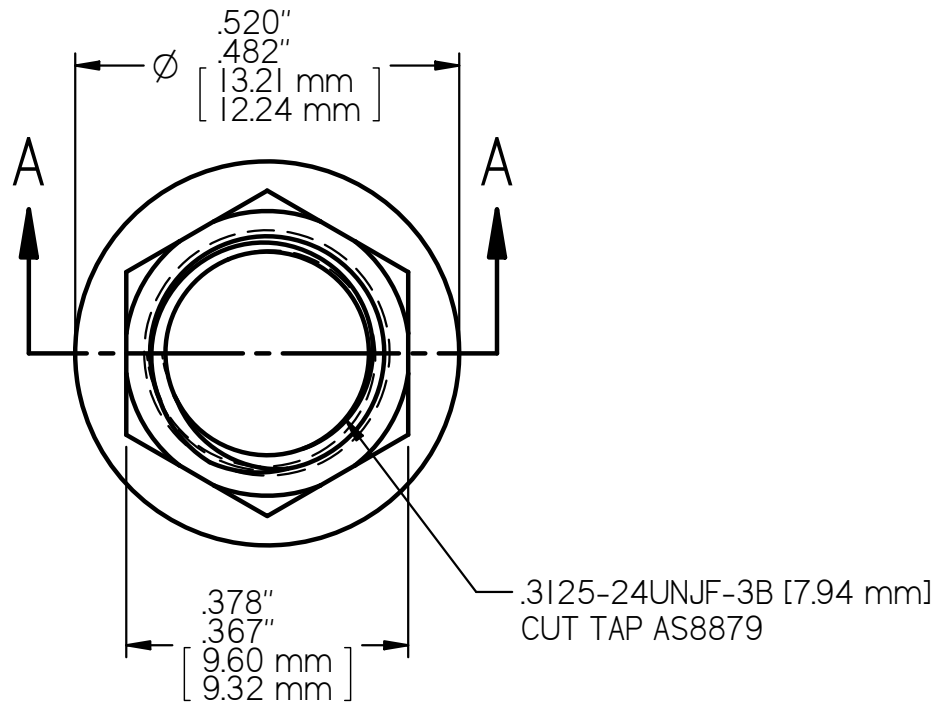

SECTION A-A  
4X SCALE

**MS21042-5 LOCK NUT**  
**AXIAL STRENGTH: 9,820 LBS. [43,682 N.] MIN**