

LEAST MATERIAL CONDITION

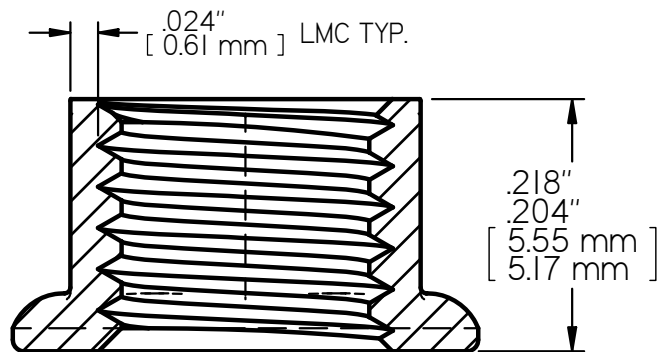
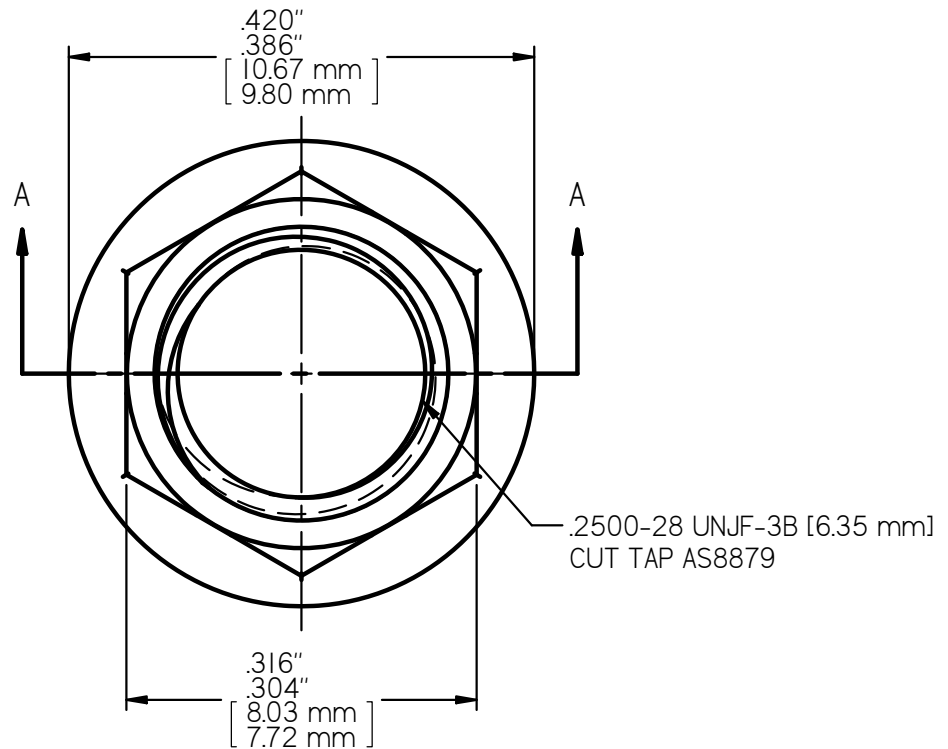

SECTION A-A
6X SCALE

MS21042-4 LOCK NUT
AXIAL STRENGTH: 6,200 LBS. [27,579 N.] MIN