

LEAST MATERIAL CONDITION

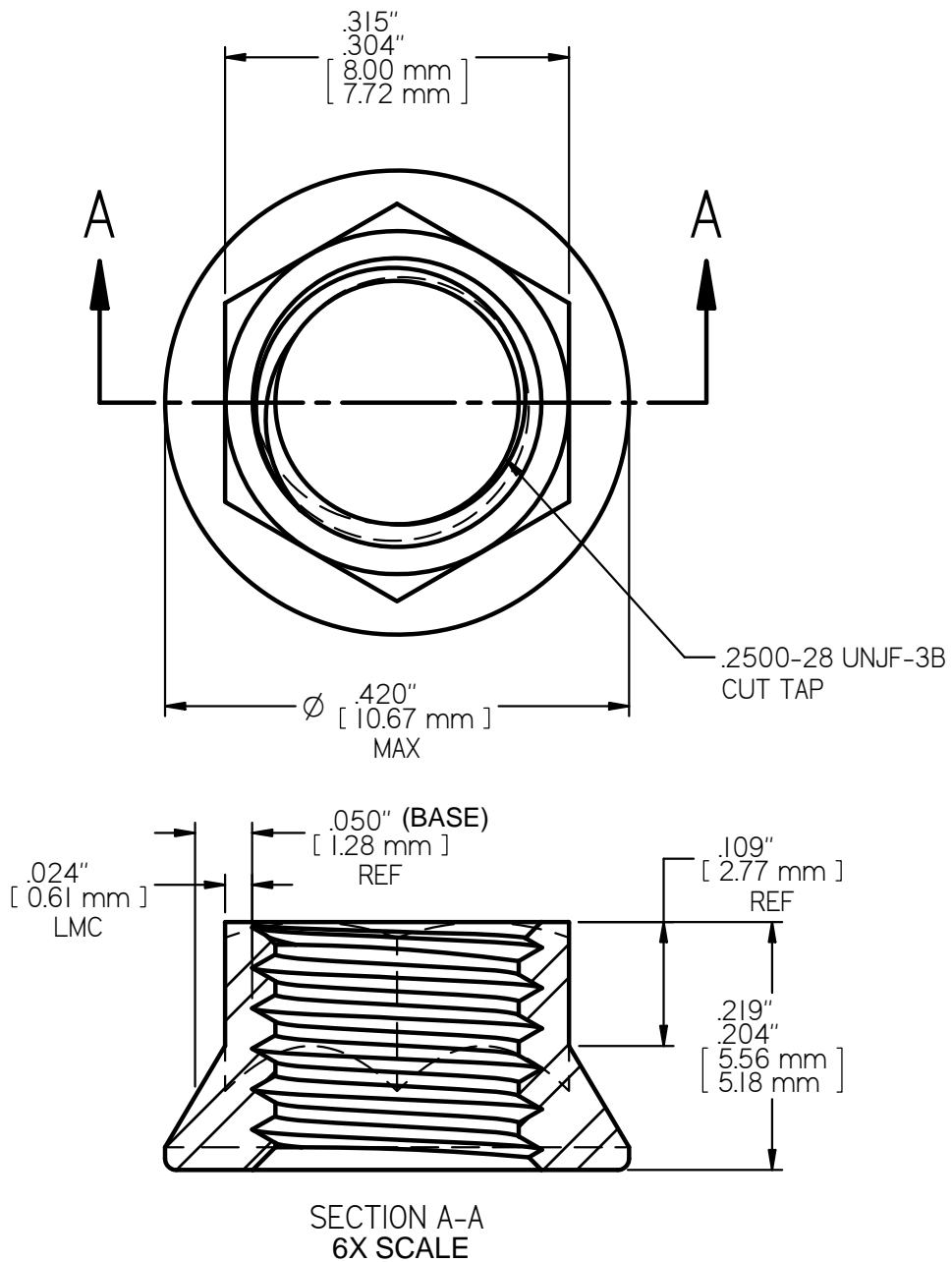

MS21042-4 LOCK NUT
STYLE "B" BELL FLANGE
AXIAL STRENGTH: 6,200 LBS. [27,579 N.] MIN