

LEAST MATERIAL CONDITION

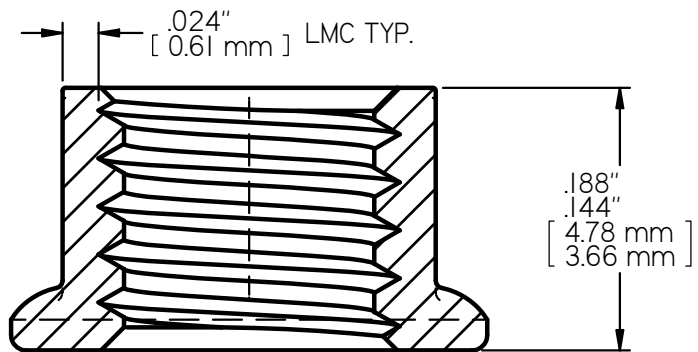
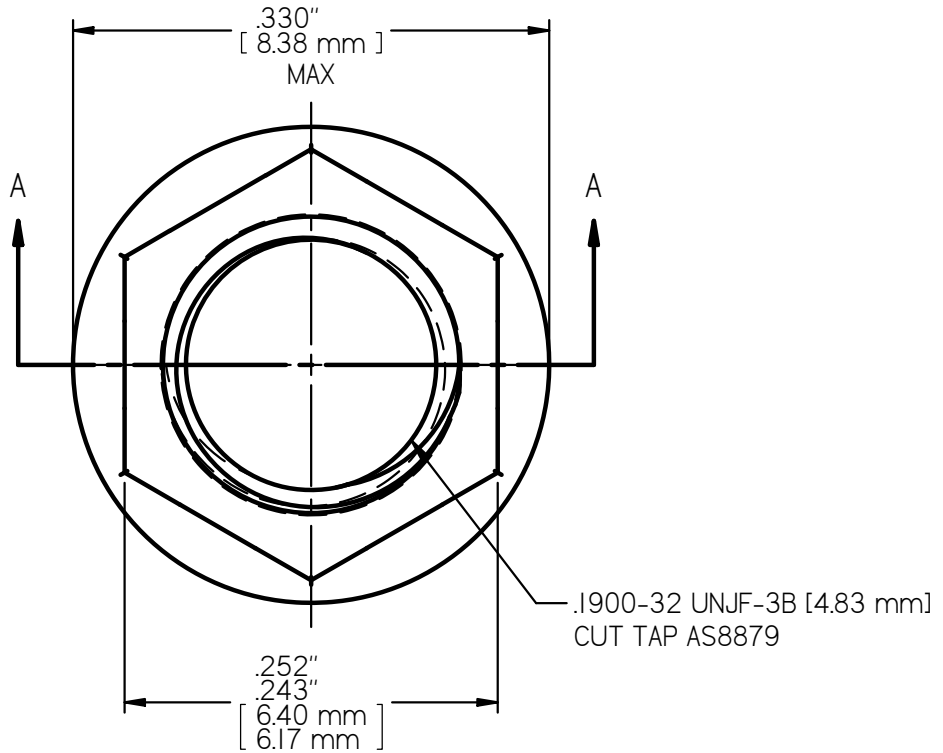

SECTION A-A
8X SCALE

MS21042-3 LOCK NUT
AXIAL STRENGTH: 3,470 LBS. [15,435 N.] MIN