

LEAST MATERIAL CONDITION

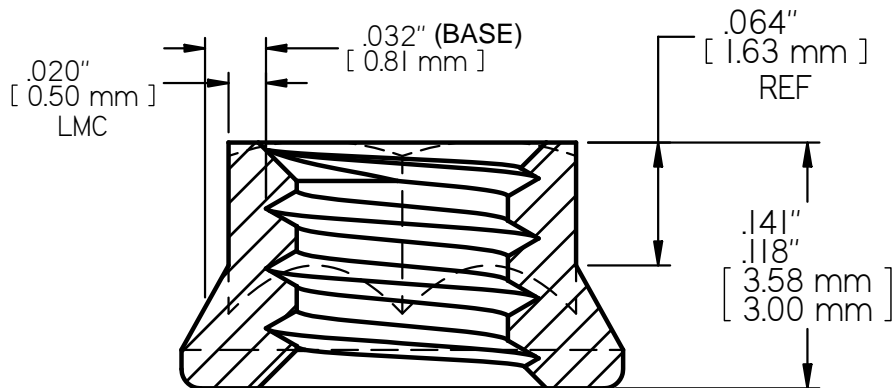
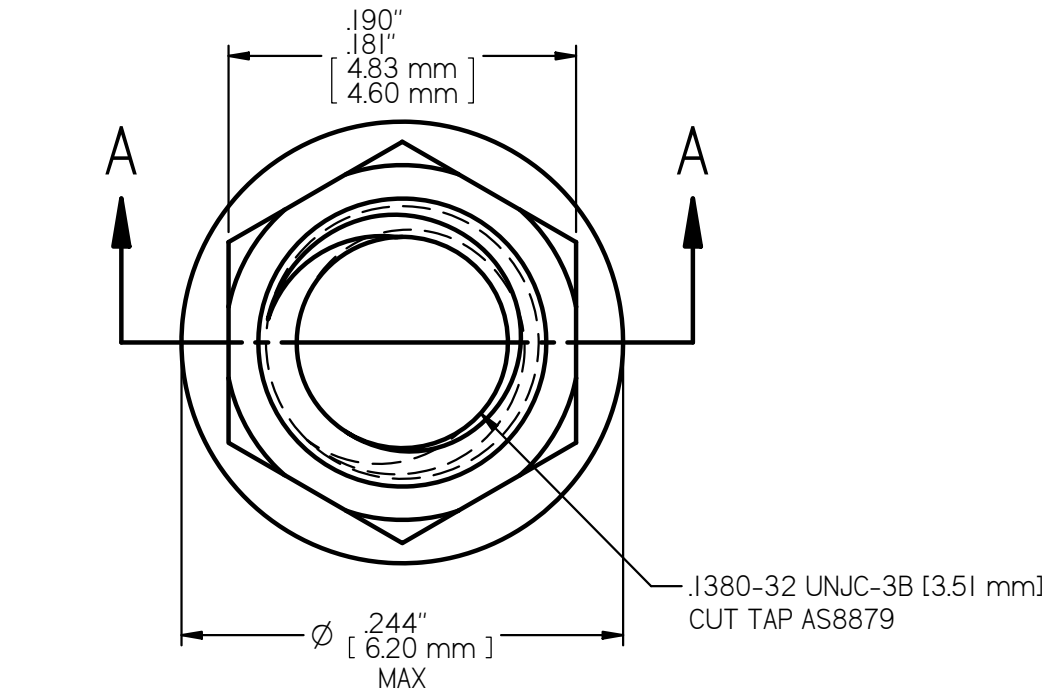

SECTION A-A
10X SCALE

**MS21042-06 LOCK NUT
STYLE "B" BELL FLANGE
AXIAL STRENGTH: 1,670 LBS. [7,429 N.] MIN**